



**ART NOVA**

**CURVE**

A termine di legge l'Azienda si riserva la proprietà della presente documentazione vietandone la riproduzione e/o la comunicazione a terzi senza la sua autorizzazione scritta.

This document is property of the Company and it shall neither be reproduced nor disclosed with any third party without a written authorization.

**Struttura portante:** in legno multistrato monoscocca. Un innovativo layer superiore in materiale elastico garantisce il molleggio.

**Preparazione della struttura di seduta:**

in poliuretano espanso a quote differenziate ad alta densità e resilienza. Layer superiore di seduta in poliuretano espanso speciale ad alta traspirabilità MEMOSOFF. Ulteriore rivestimento della struttura in microfibra "Hi-tex", accoppiata con vellutino: imbottitura di ultima generazione ad alto fattore di comfort, certificata OEKOTEX STANDARD 100, ignifuga, ecocompatibile, 100% riciclabile.

**Schienali mobili:** realizzati con 3 differenti parti in poliuretano sagomate a controllo numerico, a densità differenziata, ad alta resilienza. All'interno dell'assemblaggio delle imbottiture è predisposta una lastra d'acciaio che equilibra il manufatto. Ulteriore rivestimento dello schienale con fibra di poliestere termolegata, accoppiata con vellutino. Alla base dello schienale è predisposto, unito al rivestimento, uno speciale elastomero di derivazione nautica che permette l'ancoraggio per attrito.

**Cuscini schienale:** totalmente imbottiti in microfibra "Hi-tex" canalizzata: imbottitura di ultima generazione ad alto fattore di comfort, certificata OEKOTEX STANDARD 100, ignifuga, ecocompatibile, 100% riciclabile.

**Rivestimenti:** disponibili in tessuti elasticizzati, tessuti tradizionali o in pelle soft touch.

**Sfoderabilità:** rivestimento sfoderabile nella versione in tessuto e in pelle soft touch.

**Basamento:** speciali piedi arretrati in ABS con gomma antiscivolo che permettono il posizionamento delle composizioni divani senza ganci o connessioni fra gli elementi.

**Structure:** in plywood, monocoque with an innovative elastic material upper layer.

**Preparation of the base frame:**

in high resilience variable-density polyurethane foam. Upper layer with special breathable polyurethane foam MEMOSOFF. Outer covering with "Hi-tex" microfiber laminated to technical fiber: a last generation microfiber certificated OEKO-TEX STANDARD 100, fire resistant, 100% recyclable.

**Movable backrest:** made with 3 different high resilience polyurethane parts shaped under numerical control. Backrest construction has inside a metal plate. Additional cover in heatbonded polyester fiber laminated to technical fiber. Thanks to a special nautical elastomer fixed with the cover, backrest attach on the base.

**Backrest cushion:** channeled "Hi-tex", a last generation microfiber certificated OEKO-TEX STANDARD 100, fire resistant, 100% recyclable.

**Covers:** completely removable in all version. Covers available in stretch fabrics, traditional fabrics or soft touch leather.

**Base:** specials half-hidden ABS feet, non-slip rubber allows to join sofa without junction hook.

CURVE

Dimensioni e altezze di seduta  
Sitting depth and sofa height

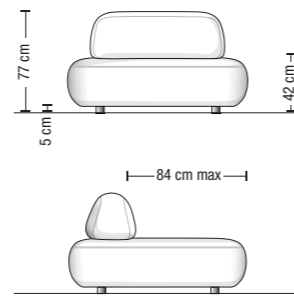

Altezza cuscino schienale  
Backrest cushion height

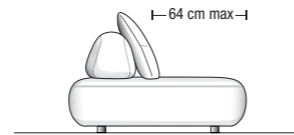
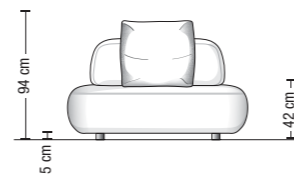

Divano da 134 cm  
Sofa 134 cm  
CV134

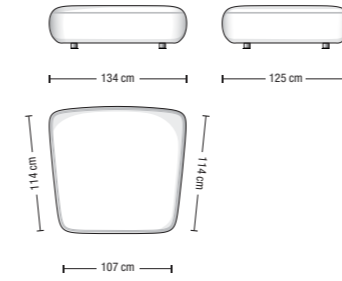

Configurazioni divano ed esempi di disposizioni schienale mobile  
Sofa layouts and movable backrest placement examples

USO INDIPENDENTE  
FREE-STANDING USE

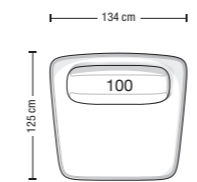

USO COMPONIBILE  
SECTIONAL USE

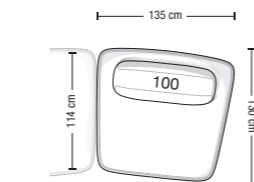

Divano da 174 cm  
Sofa 174 cm  
CV174

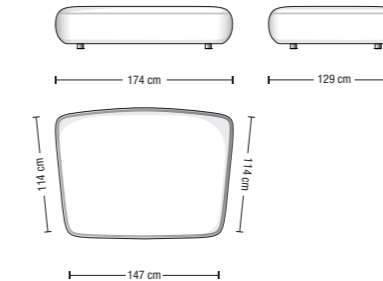

Configurazioni divano ed esempi di disposizioni schienale mobile  
Sofa layouts and movable backrest placement examples

USO INDIPENDENTE  
FREE-STANDING USE

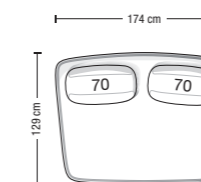

USO COMPONIBILE  
SECTIONAL USE

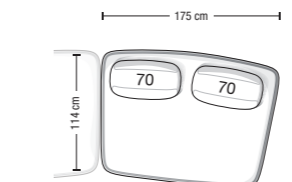

Esempio di disposizioni schienali alternative  
Alternatives backrests placement examples

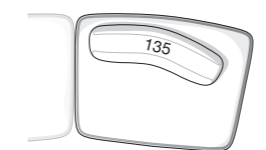

Divano da 204 cm  
Sofa 204 cm  
CV204

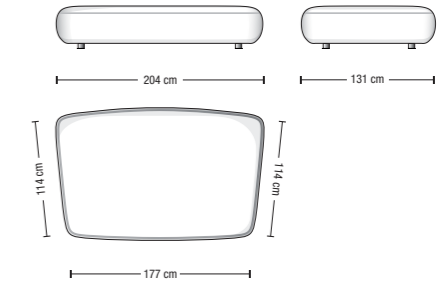

Configurazioni divano ed esempi di disposizioni schienale mobile  
Sofa layouts and movable backrest placement examples

USO INDIPENDENTE  
FREE-STANDING USE

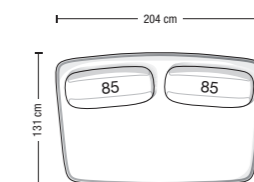

USO COMPONIBILE  
SECTIONAL USE

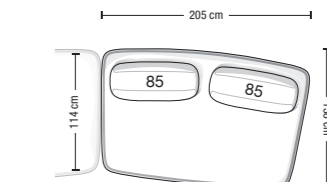

USO CHAISE-LONGUE  
CHAISE-LONGUE USE

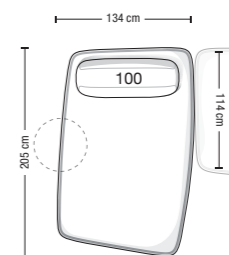

USO PENISOLA  
OPEN-END USE

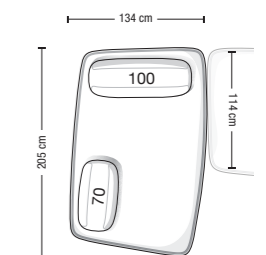

USO ANGOLARE  
CORNER USE

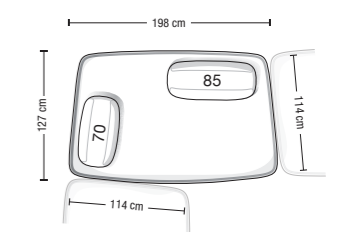
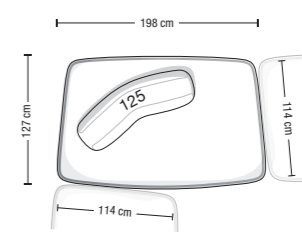

Sono disponibili misure speciali su richiesta. I disegni a catalogo sono da considerarsi suggerimenti di configurazione: schienali e cuscini sono elementi liberamente abbinabili.

Custom-made elements are available on request. Drawings are configuration suggestions: backrests and cushions are freely combinable elements.



Divano da 244 cm  
Sofa 244 cm  
**CV244**

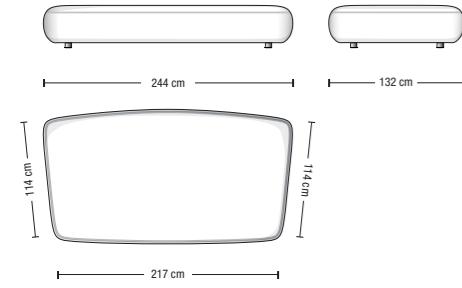

Configurazioni divano ed esempi di disposizioni schienale mobile  
Sofa layouts and movable backrest placement examples

USO INDIPENDENTE  
FREE-STANDING USE

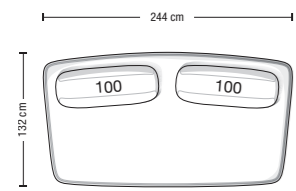

USO COMPONIBILE  
SECTIONAL USE

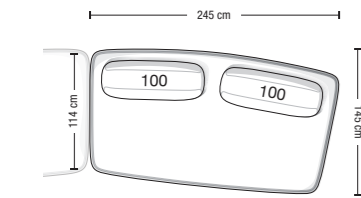

USO PENISOLA  
OPEN-END USE

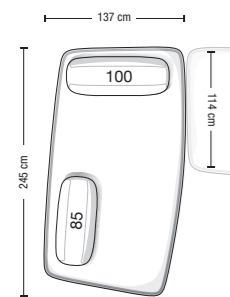

Divano da 205 cm  
Sofa 205 cm  
**CV 205B**

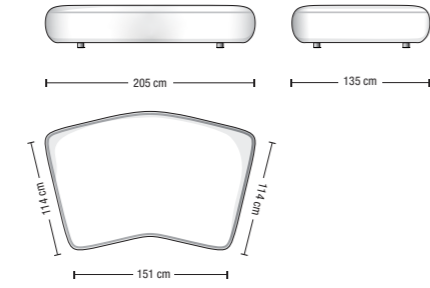

Configurazioni divano ed esempi di disposizioni schienale mobile  
Sofa layouts and movable backrest placement examples

USO INDIPENDENTE  
FREE-STANDING USE

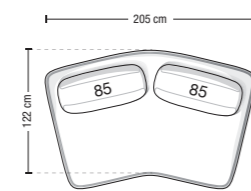

USO COMPONIBILE  
SECTIONAL USE

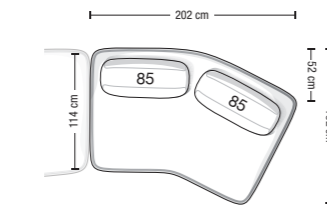

USO ANGOLARE O TERMINALE  
CORNER OR OPEN-END USE

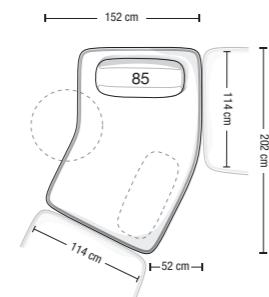

Divano da 235 cm  
Sofa 235 cm  
**CV 235B**

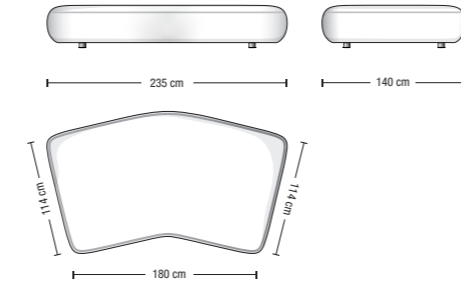

Configurazioni divano ed esempi di disposizioni schienale mobile  
Sofa layouts and movable backrest placement examples

USO INDIPENDENTE  
FREE-STANDING USE

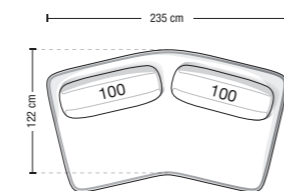

USO COMPONIBILE  
SECTIONAL USE

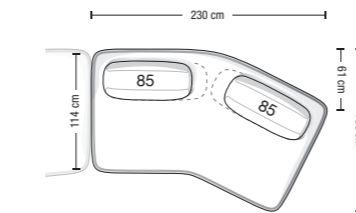

USO ANGOLARE O TERMINALE  
CORNER OR OPEN-END USE

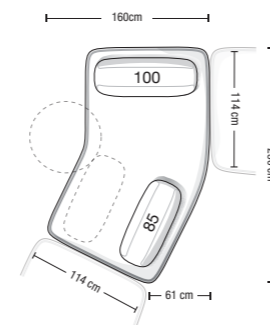

Divano da 255 cm  
Sofa 255 cm  
**CV 255B**

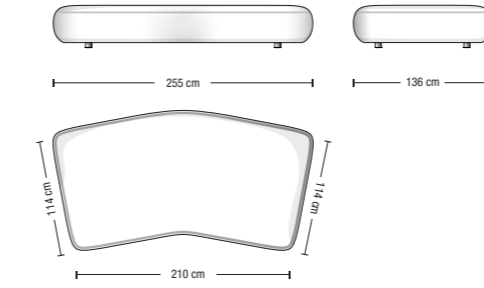

Configurazioni divano ed esempi di disposizioni schienale mobile  
Sofa layouts and movable backrest placement examples

USO INDIPENDENTE  
FREE-STANDING USE

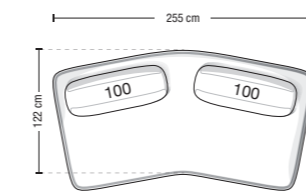

USO COMPONIBILE  
SECTIONAL USE

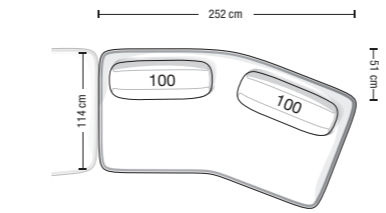

USO ANGOLARE O TERMINALE  
CORNER OR OPEN-END USE

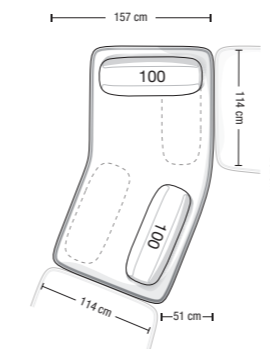

Esempio di disposizione schienali alternativa  
Alternative backrests placement example

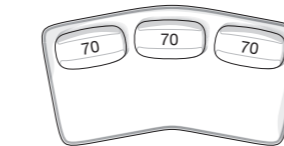

Divano da 300 cm  
Sofa 300 cm  
**CV 300B**

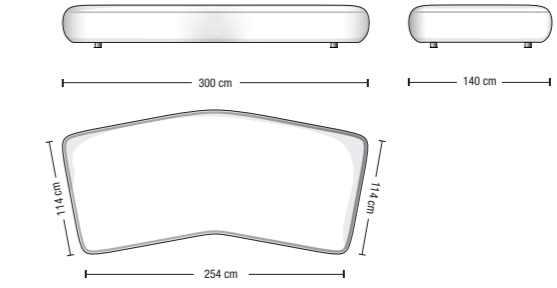

Configurazioni divano ed esempi di disposizioni schienale mobile  
Sofa layouts and movable backrest placement examples

USO INDIPENDENTE  
FREE-STANDING USE

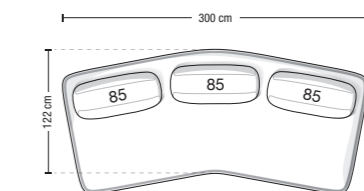

USO COMPONIBILE  
SECTIONAL USE

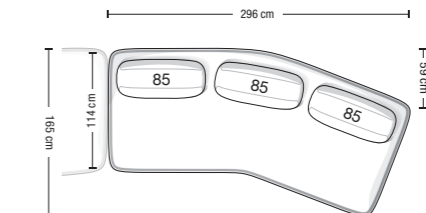

USO ANGOLARE O TERMINALE  
CORNER OR OPEN-END USE

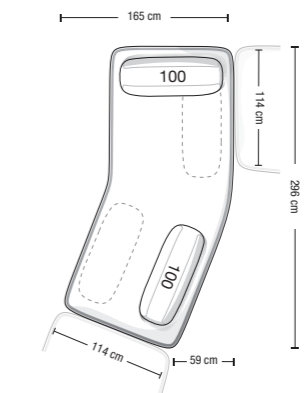

Esempio di disposizione schienali alternativa  
Alternative backrests placement example

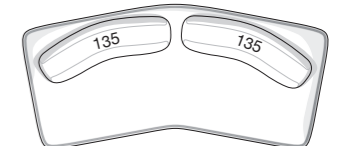

Esempio di disposizione schienali alternativa  
Alternative backrests placement example

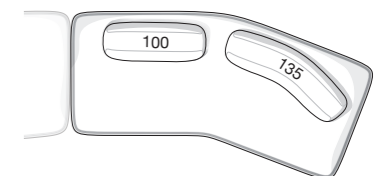

Divano da 154 cm  
Sofa 154 cm  
**CV 154CLS**

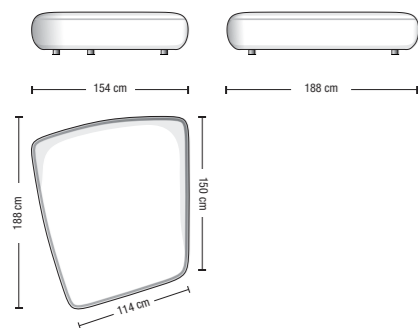

Configurazioni divano ed esempi di disposizioni schienale mobile  
Sofa layouts and movable backrest placement examples

USO COMPONIBILE  
SECTIONAL USE

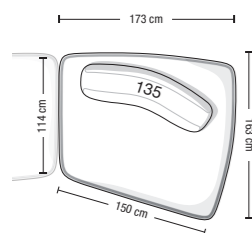

Esempio di disposizione schienali alternativa  
Alternative backrests placement example

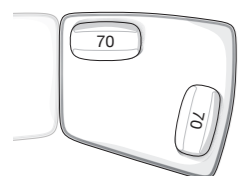

USO CHAISE-LONGUE  
CHAISE-LONGUE USE

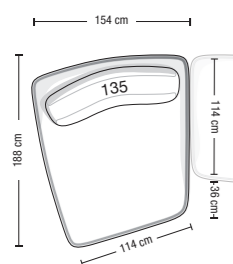

Divano da 154 cm  
Sofa 154 cm  
**CV 154CLD**

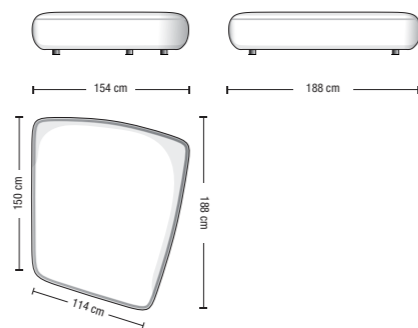

Configurazioni divano ed esempi di disposizioni schienale mobile  
Sofa layouts and movable backrest placement examples

USO COMPONIBILE  
SECTIONAL USE

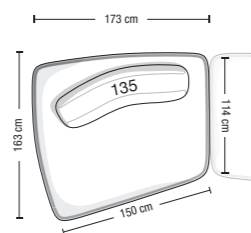

Esempio di disposizione schienali alternativa  
Alternative backrests placement example

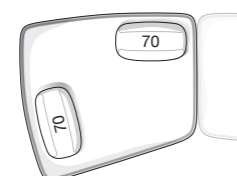

USO CHAISE-LONGUE  
CHAISE-LONGUE USE

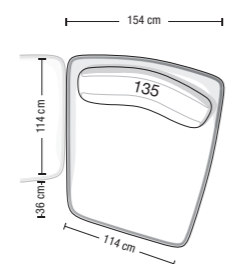

Divano da 136 cm  
Sofa 136 cm  
**CV 136A**

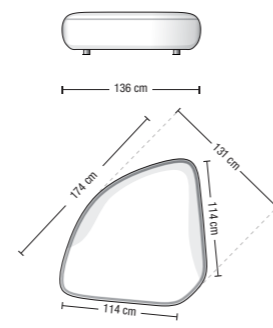

Configurazioni divano ed esempi di disposizioni schienale mobile  
Sofa layouts and movable backrest placement examples

USO ANGOLARE  
CORNER USE

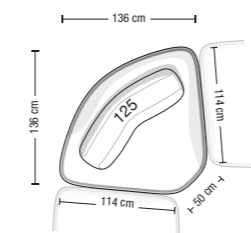

Divano da 220 cm  
Sofa 220 cm  
**CV 220P**

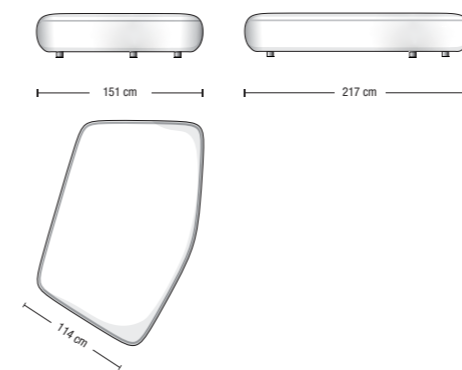

Configurazioni divano ed esempi di disposizioni schienale mobile  
Sofa layouts and movable backrest placement examples

USO INDIPENDENTE  
FREE-STANDING USE

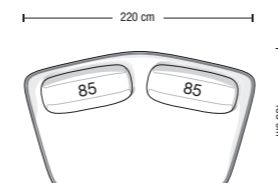

USO COMPONIBILE  
SECTIONAL USE

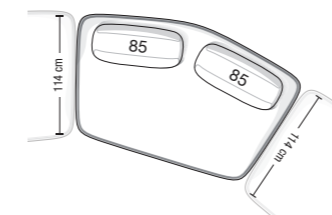

USO CHAISE-LONGUE  
CHAISE-LONGUE USE

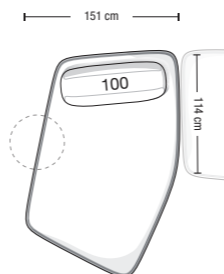

USO ANGOLARE  
CORNER USE



Esempio di disposizione schienali alternativa  
Alternative backrests placement example



USO PENISOLA  
OPEN-END USE



Schienali mobili  
Movable backrests

Schienale mobile 70  
Movable backrest 70  
**CVM70**

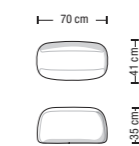

Schienale mobile 85  
Movable backrest 85  
**CVM85**

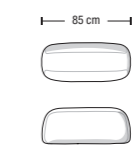

Schienale mobile 100  
Movable backrest 100  
**CVM100**

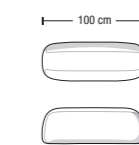

Schienale mobile 125B  
Movable backrest 125B  
**CVM125B**

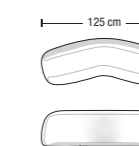

Schienale mobile 135B  
Movable backrest 135B  
**CVM135B**

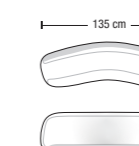

Cuscini - Schienali  
Backrest cushions

Cuscino schienale  
Backrest cushion  
**CVS**

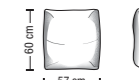

Poggiareni  
Lumbar rest  
**CVP**

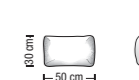

Composizioni suggerite  
Suggested Compositions

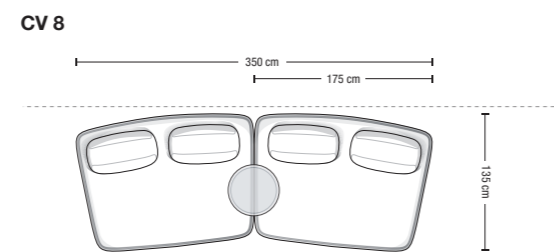
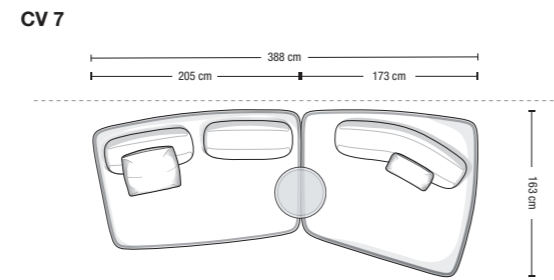
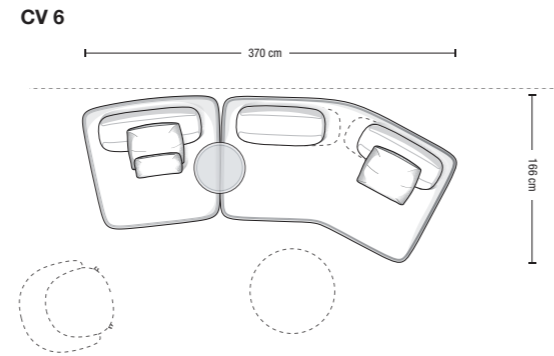
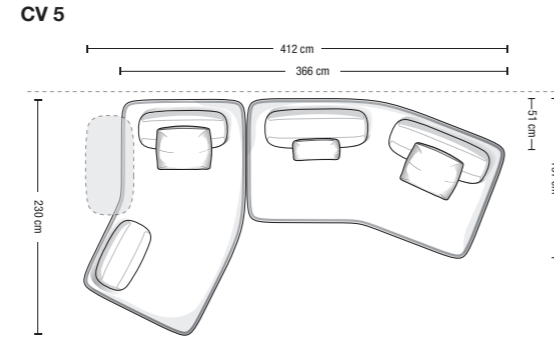
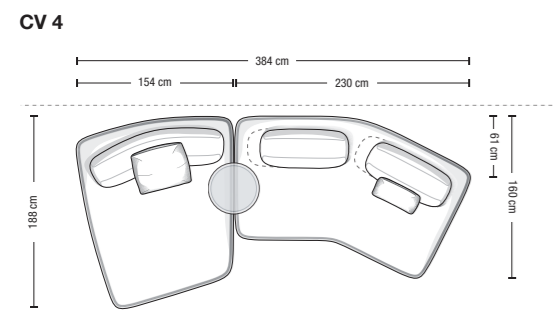
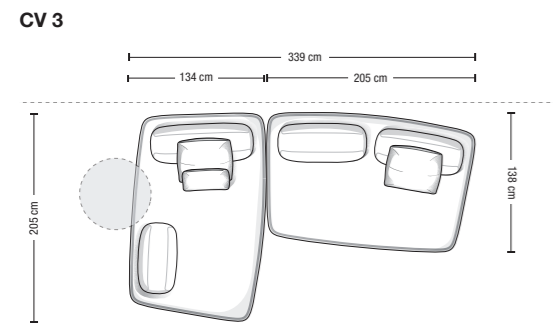
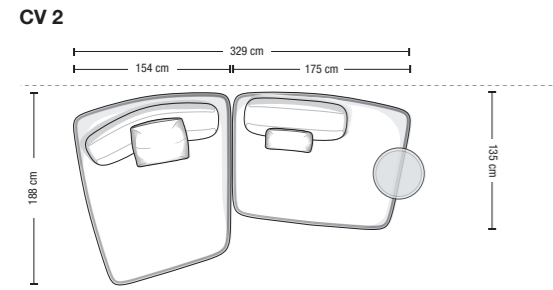
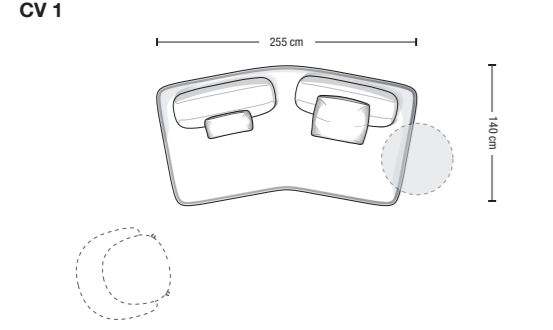

Composizioni suggerite  
Suggested Compositions

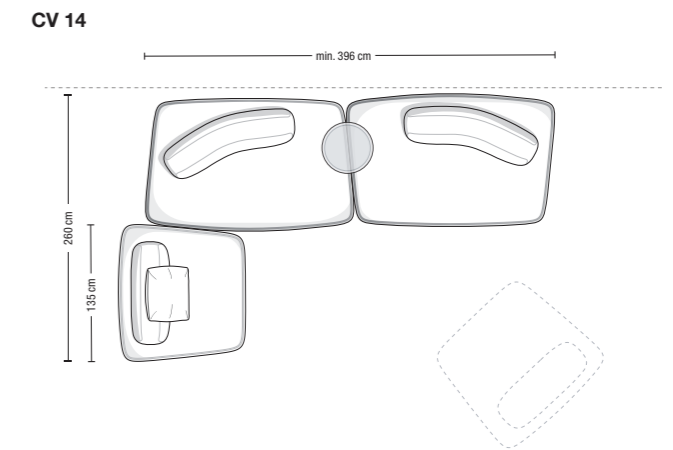
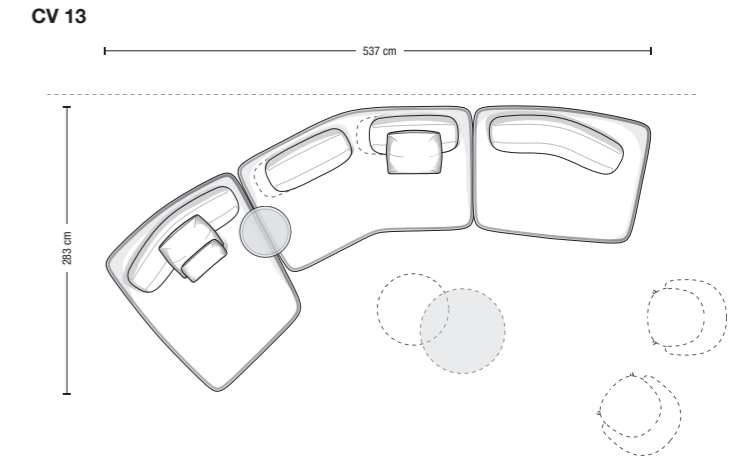
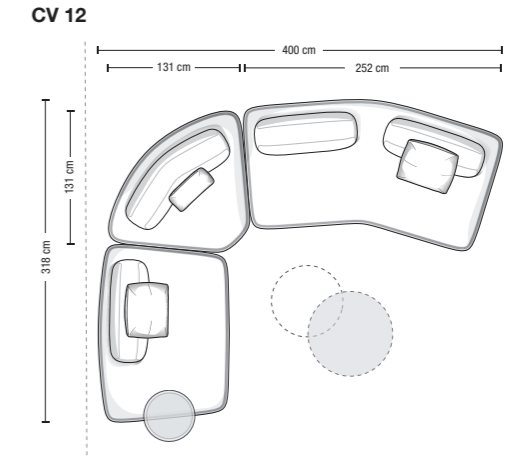
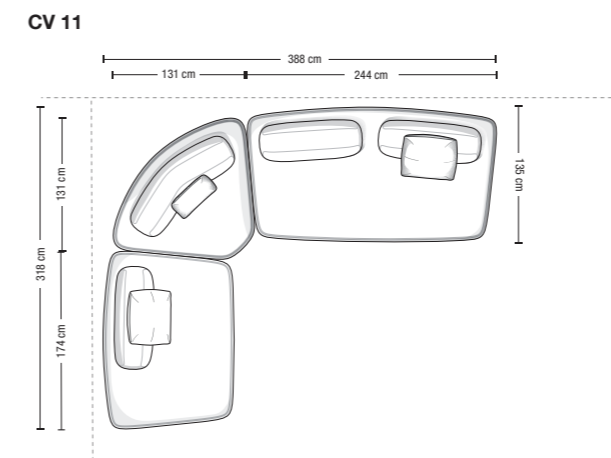
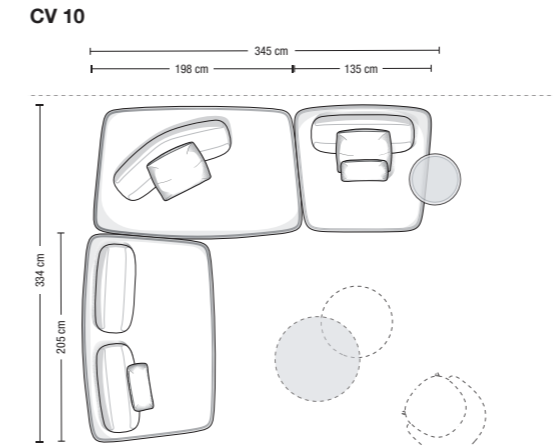
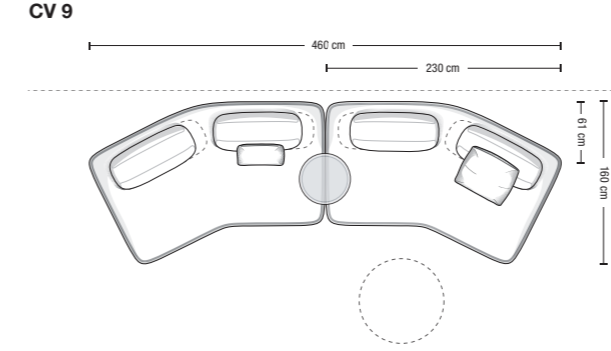

Composizioni suggerite  
Suggested Compositions  
CV 15

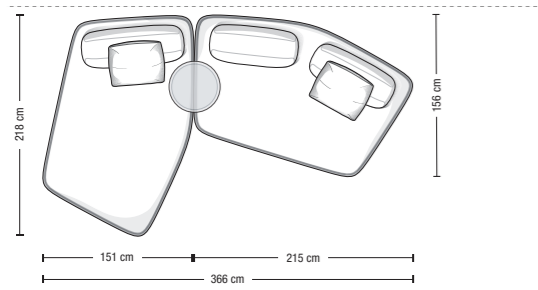

CV 16

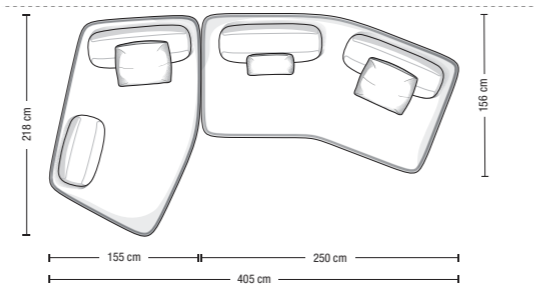

CV 17

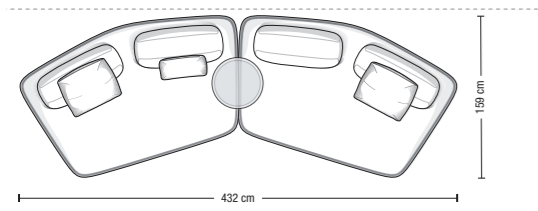

CV 18

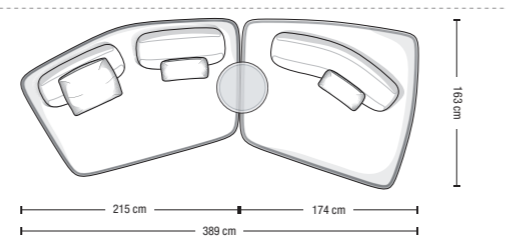

CV 19

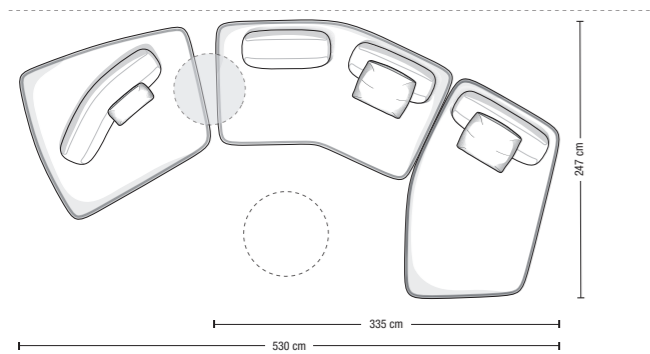

CV 20

